

Invacare® Colibri™

EN Scooter User Manual

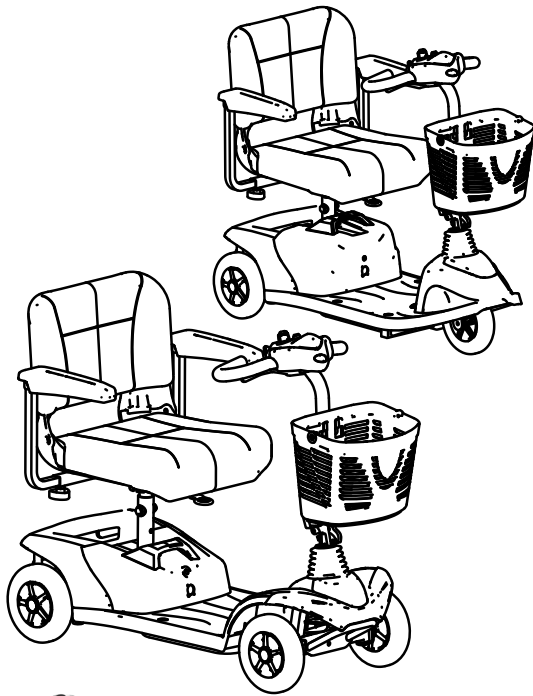

reddot award 2014
winner



This manual **MUST** be given to the user of the product.
BEFORE using this product, read this manual and save for future reference.



Yes, you can.®

© 2014 Invacare® Corporation

All rights reserved. Republication, duplication or modification in whole or in part is prohibited without prior written permission from Invacare. Trademarks are identified by ™ and ®. All trademarks are owned by or licensed to Invacare Corporation or its subsidiaries unless otherwise noted.

Contents

I	General	5
1.1	Introduction	5
1.2	Symbols in this manual	5
1.3	Type classification and intended use	6
1.4	Warranty	6
1.5	Service life	6
2	Safety	7
2.1	General safety notes	7
2.2	Safety information with regard to care and maintenance	8
2.3	Safety information on electromagnetic interference	8
2.4	Safety information on driving and freewheel mode	9
2.5	Labels on the product	10
3	Components	13
3.1	Key features	13
3.2	Operating console arrangement	13
3.2.1	Status Display	13
3.2.2	Battery charge display	14
4	Setup	15
4.1	Adjusting the armrest width	15
4.2	Adjusting the armrest angle	15
4.3	Replacing armrest pads	16
4.4	Disengaging the seat to rotate it or remove it	16
4.5	Adjusting the seat height	16
4.6	Adjusting the tiller angle	17

5	Usage	19
5.1	Getting in and out	19
5.2	Before driving for the first time	19
5.3	Taking Obstacles	20
5.3.1	Maximum obstacle height	20
5.3.2	Safety information when ascending obstacles	20
5.3.3	The correct way to overcome obstacles	20
5.4	Driving up and down gradients	20
5.5	Parking and stationary	21
5.6	Pushing the scooter by hand	21
5.6.1	Disengaging Motors	21
5.7	Driving the scooter	22
6	Electrical system	23
6.1	Electronics protection system	23
6.1.1	The main fuse	23
6.2	Batteries	23
6.2.1	General information on charging	23
6.2.2	General instructions on charging	23
6.2.3	How to charge the batteries	24
6.2.4	How to disconnect the batteries after charging	26
6.2.5	Storage and Maintenance	26
6.2.6	Instructions on using the batteries	26
6.2.7	Transporting batteries	27
6.2.8	General instructions on handling the batteries	27
6.2.9	How to handle damaged batteries correctly	27
6.3	5 A battery charger	28
6.3.1	Symbols found on the product	28
6.3.2	Features	28
6.3.3	LED display	28
6.3.4	Caution	28
6.3.5	Operating instructions	29
6.3.6	Troubleshooting	29

6.3.7	Technical specifications	29
7	Transport	31
7.1	Transport - General information	31
7.2	Dismantling the scooter for transport	31
7.2.1	Removing/Installing the battery box	31
7.2.2	Removing the drive unit	32
7.3	Reassembling the scooter	32
8	Maintenance	34
8.1	Maintenance introduction	34
8.2	Cleaning the mobility device	34
8.3	Inspection checks	34
9	After Use	36
9.1	Disposal	36
10	Troubleshooting	37
10.1	Diagnosis and fault repair	37
10.1.1	Error diagnosis	37
10.1.2	Error codes and diagnostic codes	37
10.2	Resetting the circuit breaker	39
11	Technical data	40
11.1	Technical specifications	40

I General

I.1 Introduction

Dear user,

Thank you for purchasing our product! We hope you will enjoy your new scooter.

This manual contains important hints and information on:

- **Safety**
- **Operation**
- **Care and maintenance.**

Take care to read the user manual thoroughly before starting out on your first journey.

If you find that the font size in the print version of the user manual is difficult to read, you can download it as a pdf from the Invacare website. This can then be scaled on screen to a font size that is more comfortable for you.

This product has been designed to fit the needs of different types of users with different requirements.

The decision whether the model is suitable for the user may only be taken by medical specialists with appropriate aptitude.

Invacare or their statutory representatives can accept no liability in cases in which the mobility product has not been adapted to suit the user's disabilities.

Some maintenance and settings can be carried out by the user. Certain adjustments do however require technical training and may only be carried out by your Invacare specialist dealer. Damages and errors caused by nonobservance of the user manual or as a result of incorrect maintenance are excluded from all guarantees.

This manual may contain information that pertains to models sold only in certain countries. In this case the information will be clearly marked as pertaining to a particular country-specific version. We reserve the right to make any alterations on the grounds of technical improvements.

I.2 Symbols in this manual

In this user manual warnings are indicated by symbols. The warning symbols are accompanied by a heading that indicates the severity of the danger.



WARNING

Indicates a hazardous situation that could result in serious injury or death if it is not avoided.



CAUTION

Indicates a hazardous situation that could result in minor or slight injury if it is not avoided.



IMPORTANT

Indicates a hazardous situation that could result in damage to property if it is not avoided.



Gives useful tips, recommendations and information for efficient, trouble-free use.



This product complies with Directive 93/42/EEC concerning medical devices. The launch date of this product is stated in the CE declaration of conformity.

Requirements:



This symbol identifies a list of various tools, components and items which you will need in order to carry out certain work. Please do not attempt to carry out the work if you do not have the listed tools available.

1.3 Type classification and intended use

This vehicle was designed for persons whose ability to walk is impaired, but who are still in terms of their eyesight and physically and mentally able to operate an electric vehicle. It has been classified according to EN 12184 as a **class A mobility product**. This means it is a compact, manoeuvrable vehicle mainly for internal use and not necessarily capable of negotiating outdoor obstacles.

You can find precise information about speeds, turning radius, driving range, maximum safe slope, maximum obstacle height and permissible operating conditions in chapter 11 Technical data, page 40.

Please also pay attention to all safety information in chapter 2 Safety, page 7.

The vehicle was successfully tested according to German and international standards as to its safety. It satisfies the requirements according to RoHS 2011/65/EU, REACH 1907/2006/EC and DIN EN 12184 including EN 1021-1/-2. It was also tested successfully according to EN60529 IPX4 as to its resistance to spray water, and is therefore well suited for weather conditions such as typical middle European weather conditions.

1.4 Warranty

The terms and conditions of the warranty are part of the general terms and conditions particular to the individual countries in which this product is sold.

1.5 Service life

We estimate a service life of five years for this product, provided it is used in strict accordance with the intended use as set out in this document and all maintenance and service requirements are met. The estimated service life can be exceeded if the product is carefully used and properly maintained, and provided technical and scientific advances do not result in technical limitations. The service life can also be considerably reduced by extreme or incorrect usage. The fact that we estimate a service life for this product does not constitute an additional warranty.

2 Safety

2.1 General safety notes



WARNING!

Risk of injury if this scooter is used in any other way than the purpose described in this manual!

- Adhere strictly to the instructions in this user manual.

Risk of injury if the scooter is driven when your ability to drive is impaired by medication or alcohol!

- Never drive any vehicle under the influence of medication or alcohol.

Risk of damage or injury if the scooter is accidentally set into motion!

- Switch the power system off before you get in, get out or handle awkward objects.
- Be aware that the motor brakes are automatically deactivated when the motors are disengaged. For this reason, freewheel operation is only recommended on flat surfaces, never on gradients. Never leave your vehicle on a gradient with its motors disengaged. Always re-engage the motors immediately after pushing the vehicle.



WARNING!

Risk of injury if the power is switched off while the vehicle is in motion, due to it coming to an abrupt, sharp stop!

- If you have to brake in an emergency, simply release the throttle and allow the scooter to come to a complete stop.
- If fitted, pull the handbrake until the scooter comes to a stop.
- Only switch the vehicle off while in motion as a last resort.

Risk of injury if the scooter is transported in another vehicle with the occupant seated in it!

- Never transport the scooter with the occupant seated in it.

Risk of injury if you fall off the scooter!

- If restraining systems are installed (such as seat belts), use them each time you drive the scooter.

Risk of fire or breaking down due to electric devices being connected!

- Do not connect any electric devices to your vehicle that are not expressly certified by Invacare for this purpose. Have all electrical installations done by your authorised Invacare Dealer.



CAUTION!

Risk of injury if maximum permissible load is exceeded!

- Do not exceed the maximum permissible load (refer to II Technical data, page 40).

Risk of injury when lifting heavy components!

- When maintaining, servicing or lifting any part of your scooter, take into account the weight of the individual components, especially the batteries! Be sure at all times to adopt the correct lifting posture and ask for assistance if necessary.

Risk of injury by moving parts!

- Make sure that no injury is incurred by moving parts of the scooter, like wheels or a seat lifter (if fitted), especially when children are around.

Risk of injury from hot surfaces!

- Do not leave the mobility device in direct sunlight for prolonged periods. Metal parts and surfaces such as the seat and armrests can become very hot.

Risk of technical failure and injury if unauthorized spare parts and components are used!

- Only use original Invacare spare parts, which have been approved for use with this vehicle.

2.2 Safety information with regard to care and maintenance



CAUTION!

Risk of accident and loss of warranty if maintenance is insufficient

- For reasons of safety and in order to avoid accidents which result from unnoticed wear, it is important that this electric mobility product undergoes an inspection once every year under normal operating conditions (see inspection plan contained in service instructions).
- Under difficult operating conditions such as daily travel on steep slopes, or in the case of use in medical care cases with frequently changing wheelchair users, it would be expedient to carry out intermediate checks on the brakes, accessories and running gear.

2.3 Safety information on electromagnetic interference

This electric vehicle was successfully tested in accordance with International standards as to its compliance with Electromagnetic Interference (EMI) regulations. However, electromagnetic fields, such as those generated by radio and television transmitters, and cellular phones can influence the functions of electric vehicles. Also, the electronics used in our vehicles can generate a low level of electromagnetic interference, which however will remain within the tolerance permitted by law. For these reasons we ask you to please observe the following precautions:

**WARNING!****Risk of malfunction due to electromagnetic interference**

- Do not switch on or operate portable transceivers or communication devices (such as radio transceivers or cellular phones) when the vehicle is switched on.
- Avoid getting near strong radio and television transmitters.
- In case the vehicle should be set in motion unintentionally or the brakes are released, switch it off immediately.
- Adding electrical accessories and other components or modifying the vehicle in any way can make it susceptible to electromagnetic interference. Keep in mind that there is no sure way to determine the effect such modifications will have on the overall immunity of the electronic system.
- Report all occurrences of unintentional movement of the vehicle, or release of the electric brakes to the manufacturer.

2.4 Safety information on driving and freewheel mode

**WARNING!****Risk of injury if the vehicle tips over**

- Only ever negotiate gradients up to the maximum tilt-resistant gradient and only with the backrest in an upright position, and the seat lifter in the lowest position (if installed).
- Only ever drive downhill at a maximum of 2/3 of the top speed. Avoid abrupt braking or accelerating on gradients.
- If at all possible, avoid driving on slippery surfaces (such as snow, gravel, ice etc.) where there is a risk of you losing control over the vehicle, especially on a gradient. If driving on such a surface is inevitable, then always drive slowly and with the utmost caution.
- Never attempt to overcome an obstacle when on an uphill or downhill gradient.
- Never attempt to drive up or down a flight of steps.
- Always approach obstacles straight on. Ensure that the front wheels and rear wheels move over the obstacle in one stroke, do not stop halfway. Do not exceed the maximum obstacle height (refer to II Technical data, page 40).
- Avoid shifting your centre of gravity as well as abrupt changes of direction when the vehicle is in motion.



WARNING!

Risk of injury if the vehicle tips over (continued)

- Never use the vehicle to transport more than one person.
- Do not exceed the maximum permissible load.
- When loading the vehicle, always distribute the weight evenly. Always try to keep the centre of gravity of the vehicle in the middle, and as close to the ground as possible.
- Note that the vehicle will brake or accelerate if you change the driving speed while it is in motion.

Risk of injury if you collide with an obstacle when driving through narrow passages such as doorways and entrances

- Drive through narrow passages in the lowest driving speed and with due caution.



WARNING!

The centre of gravity for the scooter is higher than that of an electric wheelchair.

There is an increased tipping hazard when negotiating bends.

- Reduce speed before negotiating bends! Only accelerate when you have come out of the bend.



WARNING!



Risk of tipping



Antitippers (stabilizers) are only effective on firm ground. They sink in on soft ground such as grass, snow or mud if the mobility device rests itself on them. They lose their effect and the mobility device can tip over.

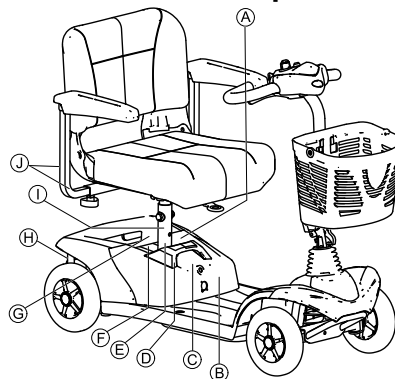

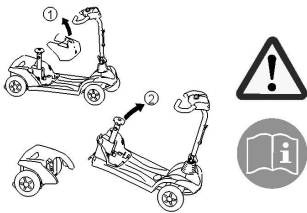

- Only drive with extreme care on soft ground, especially during uphill and downhill journeys. In the process pay increased attention to the tip stability of the mobility device.
- Keep in mind that the mobility device as a class A product is mainly for internal use and therefore not necessarily capable of negotiating outdoor obstacles.





2.5 Labels on the product



<p>(A)</p>	 <p>Pull the battery box latch to the front to release the battery box for removing</p>
<p>(B)</p>	 <p>Quick info how to disassemble the scooter. Read the user manual for more information.</p>
<p>(C)</p>	 <p>Voltage warning sign label Battery label under the cover</p>
<p>(D)</p>	 <p>Possible pinch point at seat post when battery box is removed</p>

<p>(E)</p>	 <p>European representative label on the seat post</p>
<p>(F)</p>	 <p>This product has been supplied from an environmentally aware manufacturer. This product may contain substances that could be harmful to the environment if disposed of in places (landfills) that are not appropriate according to legislation.</p> <ul style="list-style-type: none"> • The 'crossed out wheeled bin' symbol is placed on this product to encourage you to recycle wherever possible. • Please be environmentally responsible and recycle this product through your recycling facility at its end of life.
<p>(G)</p>	 <p>Drive unit warning sign label</p>

<p>Ⓜ</p>	 <p>Disengaging lever label indicating the “Push” and “Drive” position of the lever</p>
<p>ⓘ</p>	 <p>Identification label sticker on the seat post containing the following symbols:</p>
<p></p>	 <p>Date of manufacture</p>
<p></p>	 <p>This product complies with Directive 93/42/EEC concerning medical devices. The launch date of this product is stated in the CE declaration of conformity.</p>

<p></p>	 <p>The product needs to be tied down at indicated anchor points with a lashing system during transport.</p>
<p></p>	 <p>This product may not be used as a vehicle seat.</p>
<p></p>	
<p></p>	 <p>See above</p>
<p>ⓘ</p>	 <p>This symbol indicates the maximum width to which an armrest may be adjusted. Pulling the armrest out further can cause it to fall out of its fixation.</p>

3 Components

3.1 Key features

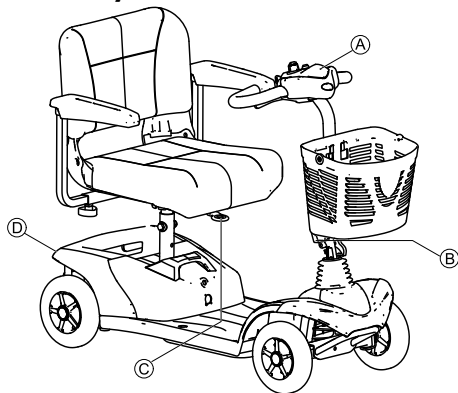

(A)	Operating console (3)
(B)	Lever for adjusting tiller inclination (4)
(C)	Unlocking lever for swivelling and removing seat (front below seat) (2)
(D)	Disengaging lever (1)

3.2 Operating console arrangement

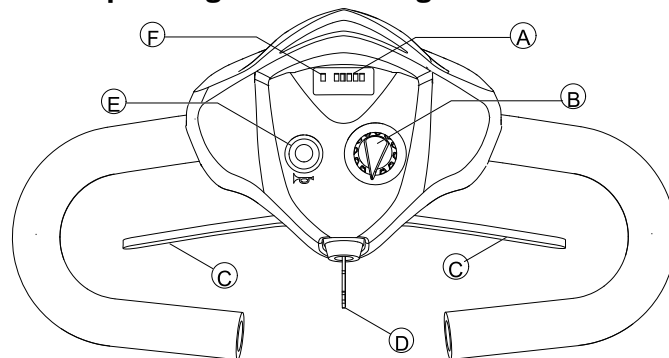

(A)	Battery charge display (1)
(B)	Speed controller (5)
(C)	Drive lever (6)
(D)	Keyswitch (ON/OFF) (4)
(E)	Horn (2)
(F)	Status display / ON/OFF diode(3)

3.2.1 Status Display



NOTE:

- The ON/OFF diode is used as a fault display (status display). It will flash if there is a problem with the scooter. The number of flashes indicates the type of error. Refer to 10.1.2 Error codes and diagnostic codes, page 37.

3.2.2 Battery charge display

- All diodes illuminate: maximum driving range
- Only red and yellow diodes illuminate: reduced driving range. Recharge the batteries at the end of your journey.
- **Only red LEDs illuminate/blink, electronic beeps 3x: battery reserve = severely restricted driving range. Recharge batteries immediately!**



NOTE:

- Overdischarge protection: after a certain drive time on reserve battery power the electronics system switches the drive off automatically and brings the Scooter to a standstill. If you do not drive your Scooter for a while the batteries will "recuperate" and allow a further, but short, journey. However, after a very brief journey the red diodes will illuminate again and the electronic system will beep three times. This procedure leads to battery damage and should be avoided if possible!

4 Setup

4.1 Adjusting the armrest width



WARNING!

Serious injury hazard if one of the armrests falls out of its bracket because they have been adjusted to a width which exceeds the permissible value

- The width adjustment is fitted with small stickers with markings and the word "STOP". The armrests must never be pulled out further than the point at which the word "STOP" is completely legible.
- Always tighten the fixing screws properly once adjustments have been completed.

STOP

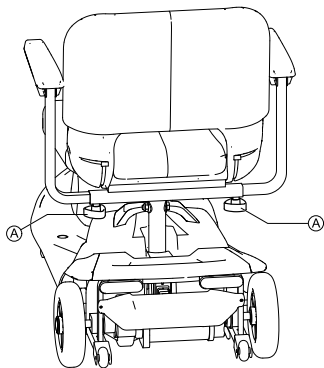

The knobs for releasing the armrests are located under the seat (A).

1. Turn the knobs to loosen the fixing for the armrest.
2. Adjust the armrests to the required width.
3. Retighten the knobs.

4.2 Adjusting the armrest angle



CAUTION!

Pinch point may occur when adjusting the arm angle

- Pay attention to your fingers.

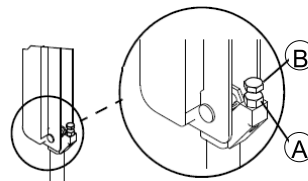

1. Lift up the armrest.
2. Loosen the jam nut (A).
3. Adjust the socket screw (B) up or down to the desired arm angle position.
4. Tighten the jam nut.
5. To determine the same angle for the opposite armrest, count the exposed threads after the jam nut has been tightened.
6. Repeat STEPS 1-4 for opposite armrest, if necessary.

4.3 Replacing armrest pads

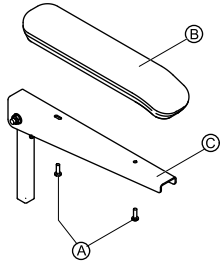

1. Remove the two mounting screws (A) that secure the armrest pad (B) to the arm (C).
2. Remove the old armrest pad.
3. Install the new armrest pad and securely tighten with the existing mounting screws.
4. If necessary, repeat STEPS 1-3 to replace the other armrest pad.

4.4 Disengaging the seat to rotate it or remove it

The seat can be turned to one side to make getting in and out of the scooter easier. The seat is also easier to remove from this position.

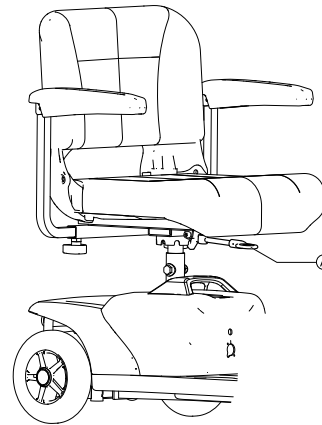

The seat lever (A) is located under the seat in the front.

Rotating the seat

1. Pull the lever upwards to disengage the seat.
2. Turn the seat to the side.

Removing the seat

1. Pull the lever upwards to disengage the seat.
2. Hold the seat firmly by the backrest and front edge and remove it upwards.

Installing the seat

1. Lower the seat assembly onto the seat post.
2. Allow the seat to drop into the locked position.
3. Lift up on the seat assembly to ensure the seat is secure.

4.5 Adjusting the seat height

The seat height can be adjusted to 390, 410, or 430 mm.



Requirements:

- 2 x open-ended spanners 17 mm

1. Remove the seat.
- 2.

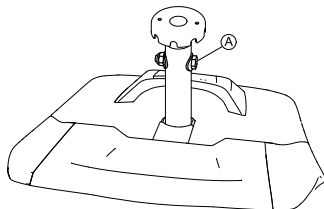

Remove the seat post locking bolt (A) using both open-ended spanners.

- 3.



Adjust the seat height.

4. Replace the securing bolt and tighten.

4.6 Adjusting the tiller angle



WARNING!

Risk of injury if tiller is not locked into position

- Ensure that the tiller is properly adjusted before driving the scooter.
- After making any tiller angle adjustments and before use, the tiller **MUST** be securely locked into position. Otherwise, a fall from the scooter could occur causing bodily injury and/or damage to the scooter. Gently, push/pull against tiller to ensure that the tiller is securely engaged into the adjustment plate.

The tiller locks into one of three positions. The tiller can also be folded down for transportation and storage.

Adjusting the tiller angle

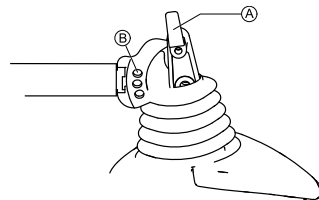

1. Rotate or pull out the tiller adjustment lever (A) until the pin disengages from the mounting hole.
2. Move the tiller to the desired position.
3. Release or rotate the tiller adjustment lever to lock the pin into the desired mounting hole (B).
4. Gently push/pull against tiller to ensure that the tiller is securely locked.

Folding down the tiller

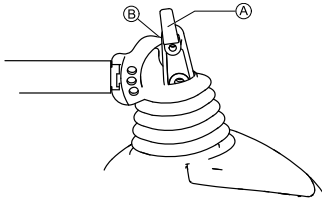

1. Rotate or pull out the tiller adjustment lever **A** until the pin disengages from the mounting hole.
2. Fold down the tiller.
3. Release or rotate the tiller adjustment lever to lock the pin above the tiller base **B**.
4. Gently push/pull against tiller to ensure that the tiller is securely locked.

You can now use the tiller as a handle to transport the front frame assembly:

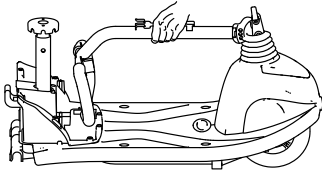

5 Usage

5.1 Getting in and out

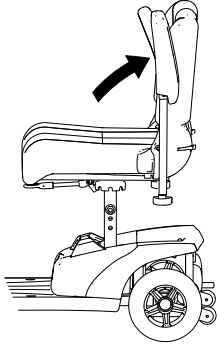

The armrests can be swivelled upwards to assist getting in and out.

The seat can also be rotated to assist getting in and out.

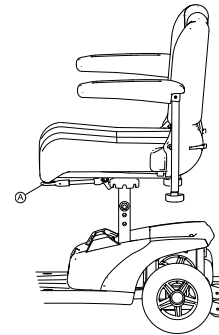

1.

Lift the detent lever **A** up.

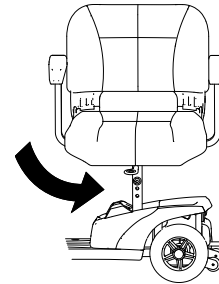

2.

Turn the seat to the side.



Information on turning the seat

- The detent automatically engages again in eighth-turns.

5.2 Before driving for the first time

Before you take your first trip, you should familiarise yourself well with the operation of the vehicle and with all operating elements. Take your time to test all functions and driving modes.



NOTE

- If installed, make sure to properly adjust and use the postural belt each time you use the wheelchair.

Sitting comfortably = Driving safely

Before each trip, make sure that:

- You are within easy reach of all operating controls.
- The battery charge is sufficient for the distance intended to be covered.
- The postural belt (if installed) is in perfect order.
- The rear mirror (if installed) is adjusted so you can look behind at all times without having to bend forward or shift your seating position.

5.3 Taking Obstacles

5.3.1 Maximum obstacle height

You can find information about maximum obstacle heights in the chapter entitled || Technical data, page 40.

5.3.2 Safety information when ascending obstacles



WARNING!

Risk of tipping over

- Never approach obstacles at an angle but at 90 degrees as shown below.
- Put your backrest into an upright position before climbing an obstacle.

5.3.3 The correct way to overcome obstacles

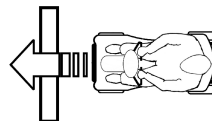

Right

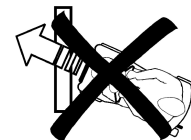

Wrong

Driving up over an obstacle

1. Approach the curb or obstacle slowly head-on. Shortly before the front wheels touch the obstacle, increase the speed and reduce only after the rear wheels have also climbed the obstacle.

Driving down off of an obstacle

1. Approach the curb or obstacle slowly head-on. Before the front wheels touch the obstacle, reduce speed and keep it until also the rear wheels have come down off of the obstacle.

5.4 Driving up and down gradients

For information concerning the maximum safe slope, refer to || Technical data, page 40.



WARNING!

Risk of tipping over

- Only ever drive downhill at a maximum of 2/3 of the top speed.
- If your scooter is fitted with an adjustable backrest, always return the backrest of your seat to an upright position before ascending slopes. We recommend that you lean the backrest slightly to the rear before descending slopes.
- Never attempt to ascend or descend a slope on slippery surfaces or where there is a danger of skidding (such as wet pavement, ice etc).
- Avoid trying to get out of the scooter on an incline or a gradient.
- Always drive in a straight direction along the road or path you are travelling on, rather than attempting to zigzag.
- Never attempt to turn around on an incline or a slope.

5.5 Parking and stationary

If you park your vehicle, or leave it idle or unattended for a longer period:

1. Switch off the power supply (keyswitch) and remove key.

5.6 Pushing the scooter by hand

The motors of the scooter are fitted with automatic brakes, preventing the scooter from rolling away out of control when the power supply is switched off. When pushing the scooter, the magnetic brakes must be disengaged.

5.6.1 Disengaging Motors



CAUTION!

Risk of the vehicle running away

- When the motors are disengaged (for push operation whilst freewheeling), the electromagnetic motor brakes are deactivated. When the vehicle is parked, the levers for engaging and disengaging the motors must without fail be locked firmly into the "DRIVE" position (electromagnetic motor brakes activated).

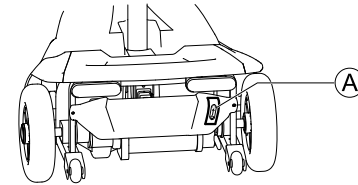

The lever for engaging and disengaging the motor is located on the right-hand side at the rear.

Disengaging the drive

1. Switch off the scooter (keyswitch).
2. Pull the disengaging lever **A** up.
The drive is now disengaged.

Engaging the drive

1. Push the disengaging lever **A** down.
The drive is now engaged.

5.7 Driving the scooter



WARNING!

Risk of injury from the unintended rolling of the vehicle

When stopping the vehicle, the drive lever needs to return entirely to the middle position to activate the electromagnetic brakes. If there is any obstruction stopping the lever from returning to the middle position, the electromagnetic brakes cannot be activated. This can lead to the vehicle rolling unintentionally.

- Ensure that the drive lever is in the middle position, if the vehicle is to remain stationary.

1. Switch the power supply on (keyswitch).
The operating console display illuminates. The scooter is ready to drive.



NOTE:

- If the scooter is not ready to drive after switching on, check the status display (refer to 3.2.1 Status Display, page 13 and chapter 10.1 Diagnosis and fault repair, page 37).

2. Set the required speed with the speed controller.
3. Pull the right-hand drive lever carefully to travel forwards.
4. Pull the left-hand drive lever carefully to travel in reverse.



NOTE:

- The control system is programmed with standard values in the works. Your Invacare dealer can carry out programming tailored to fit your requirements.



WARNING!

Any changes to the drive program can affect the driving characteristics and the tipping stability of the vehicle.

- Changes to the drive program may only be carried out by trained Invacare specialist dealers.
- Invacare supplies all mobility products with a standard drive program ex-works. Invacare can only give a warranty for safe vehicle driving behavior - especially the tipping stability - for this standard drive program.



NOTE:

- To brake quickly, simply let go of the drive lever. It will then automatically return to the middle position. The scooter will brake.

6 Electrical system

6.1 Electronics protection system

The vehicle's electronics are fitted with an overload-protection system.

If the motors are put under considerable strain for a longer period of time (for example, when driving up a steep hill) and especially when the ambient temperature is high, then the electronic system could overheat. In this case the vehicle's power is reduced gradually until it finally comes to a halt. The status display shows a corresponding error code (refer to 10.1.2 Error codes and diagnostic codes, page 37). By switching the power supply off and back on again, the error code is cancelled and the electronics are switched back on. It will take approximately five minutes until the electronics have cooled down enough for the motors to restore full power again.

When the motors are stalled by an insurmountable obstacle, such as a high curb, and the vehicle driver allows the motors to strain against this hindrance for more than 20 seconds without moving, then the electronics will automatically switch off to prevent the motors from being damaged. The status display shows a corresponding error code (refer to 10.1.2 Error codes and diagnostic codes, page 37). By switching off and back on again, the error code is cancelled and the electronics are switched back on.

6.1.1 The main fuse

The entire electric system is protected against overload by two master fuses. The master fuses are mounted on the positive battery cables.



NOTE

– A defective main fuse may be replaced only after checking the entire electric system. An Invacare specialised dealer must perform the replacement. You can find information on the fuse type in chapter 11 Technical data, page 40.

6.2 Batteries

Power is supplied by two 12 V batteries. The batteries are maintenance-free and only need regular charging.

In the following, you find information on how to charge, handle, transport, store, maintain, and use batteries.

6.2.1 General information on charging

New batteries should always be fully charged once before their first use. New batteries will be at their full capacity after having run through approx. 10 - 20 charging cycles (break-in period). This break-in period is necessary to fully activate the battery for maximum performance and longevity. Thus, range and running time of your mobility device could initially increase with use.

Gel/AGM lead acid batteries do not have a memory effect as NiCd batteries.

6.2.2 General instructions on charging

Follow the instructions listed below to ensure safe use and longevity of the batteries:

- Charge 18 hours prior to initial usage.
- We recommend charging the batteries daily after every discharge even after partly discharge, as well as each night over night. Depending on the level of discharge, it can take up to 12 hours until the batteries are fully charged again.

- When the battery indicator reached the red LED range, charge the batteries for 16 hours minimum, neglecting the charge complete display!
- Try to provide a 24 hour charge once a week to make sure that both batteries are fully charged.
- Do not cycle your batteries at a low state of charge without regularly recharging them fully.
- Do not charge your batteries under extreme temperatures. High temperatures above 30 °C are not recommended for charging as well as low temperatures below 10 °C.
- Use only charging devices in Class 2. This class of chargers may be left unattended during charging. All charging devices which are supplied by Invacare comply with these requirements.
- You cannot overcharge the batteries when using the charger supplied with your vehicle, or a charger that has been approved by Invacare.
- Protect your charger from sources of heat such as heaters and direct sunlight. If the battery charger overheats, charging current will be reduced and the charging process delayed.

6.2.3 How to charge the batteries

- I. Make sure you read and understand the battery charger's user manual, if supplied, as well as the safety notes on the front and rear panels of the charger.

**WARNING!****Risk of explosion and destruction of batteries if the wrong battery charger is used**

- Only ever use the battery charger supplied with your vehicle, or a charger that has been approved by Invacare.
- Never charge 12 Ah batteries with a 5 A battery charger. Always use a 2 Ah battery charger.

Risk of electric shock and damage to the battery charger if it gets wet

- Protect the battery charger from water.
- Always charge in a dry environment.

Risk of short circuit and electric shock if the battery charger has been damaged

- Do not use the battery charger if it has been dropped or damaged.

Risk of electric shock and damage to the batteries

- NEVER attempt to recharge the batteries by attaching cables directly to the battery terminals.

Risk of fire and electric shock if a damaged extension cable is used

- Only ever use an extension cable if it is absolutely necessary. In case you must use one, make sure it is in good condition.

Risk of injury if using the wheelchair during charging

- DO NOT attempt to recharge the batteries and operate the wheelchair at the same time.
- DO NOT sit in the wheelchair while charging the batteries.

The charging socket is located under the seat

1. Switch off the scooter.
2. Fold up the charging socket protective cap.
3. Connect the battery charger to the scooter.
4. Connect the battery charger to the power supply.

6.2.4 How to disconnect the batteries after charging

1. Disconnect the battery charger from the power supply.
2. Disconnect the battery charger from the scooter.
3. Close the charging socket protective cap.

6.2.5 Storage and Maintenance

Follow the instructions listed below to ensure safe use and longevity of the batteries:

- Always store the batteries fully charged.
- Do not leave the batteries in a low state of charge for an extended length of time. Charge a discharged battery as soon as possible.
- In case your mobility device is not used for a longer period of time (that is more than two weeks), the batteries must be charged at least once a month to maintain a full charge and always be charged before use.
- Avoid hot and cold extremes when storing. We recommend to store batteries at a temperature of 15 °C.
- Gel and AGM batteries are maintenance-free. Any performance issues should be handled by a properly trained mobility device technician.

6.2.6 Instructions on using the batteries



CAUTION!

Risk of damaging the batteries.

- Avoid ultra-deep discharges and never drain your batteries completely.

- Pay attention to the Battery Charge Indicator! Charge the batteries when the Battery Charge Indicator shows that battery charge is low.
How fast the batteries discharge depends on many circumstances, such as ambient temperature, condition of the surface of the road, tire pressure, weight of the driver, way of driving and utilisation of lighting.
- Try to charge the batteries always before you reach the red LED range.
The last 2 LED (one red and one orange) mean a remaining capacity of 20 — 30 %.
- Driving with blinking red LED means an extreme stress for the battery and should be avoided under normal circumstances.
- When only one red LED is blinking, the Battery Safe feature is enabled. From this time, speed and acceleration is reduced drastically. It will allow you to move the mobility device slowly out of a dangerous situation before the electronic finally cuts off. This is deep discharging and should be avoided.
- Be aware that for temperatures below 20 °C, the nominal battery capacity starts to decline. For example, at -10 °C the capacity is reduced to about 50 % of the nominal battery capacity.
- To avoid damaging the batteries, never allow them to be fully discharged. Do not drive on heavily discharged batteries if it is not absolutely necessary, as this will strain the batteries unduly and shorten their life expectancy.
- The earlier you recharge the batteries, the longer they live.

- The depth of discharge affects the cycle life. The harder a battery has to work, the shorter is its life expectancy.
Examples:
 - One deep discharge stresses the same as 6 normal cycles (green /orange display off).
 - The battery life is about 300 cycles at 80% discharge (first 3 LED off), or about 3000 cycles at 10% discharge.
- Under normal operation, once a month the battery should be discharged until all green and orange LED are off. This should be done within one day. A 16 hour charge afterwards is necessary as reconditioning.

6.2.7 Transporting batteries

The batteries supplied with your electric vehicle are not hazardous goods. This classification is based on the German GGVS Hazardous Goods Road Transport Ordinances, and the IATA/DGR Hazardous Goods Rail Transport / Air Transport Ordinances. Batteries may be transported without restrictions, whether by road, rail or by air. Individual transport companies have, however, guidelines which can possibly restrict or forbid certain transport procedures. Please ask the transport company regarding each individual case.

6.2.8 General instructions on handling the batteries

- Never mix and match different battery manufactures or technologies, or use batteries that do not have similar date codes.
- Never mix gel with AGM batteries.
- Always have your batteries installed by a properly trained mobility device technician. They have the necessary training and tools to do the job safely and correctly.

6.2.9 How to handle damaged batteries correctly



CAUTION!

Corrosion and burns from acid leakage if batteries are damaged

- Remove clothes that have been soiled by acid immediately.

After contact with skin:

- Immediately wash affected area with lots of water.

After contact with eyes:

- Immediately rinse eyes under running water for several minutes; consult a physician.





- Always wear safety goggles and appropriate safety clothing when handling damaged batteries.
- Place damaged batteries in an acid-resistant receptacle immediately after removing them.
- Only ever transport damaged batteries in an appropriate acid-resistant receptacle.
- Wash all objects that have come into contact with acid with lots of water.

Disposing of dead or damaged batteries correctly

Dead or damaged batteries can be given back to your dealer or directly to Invacare.

6.3 5 A battery charger

6.3.1 Symbols found on the product

	This product complies with Directive 93/42/EEC concerning medical devices. The launch date of this product is stated in the CE declaration of conformity.
	C-Tick (Australian EMC)
	This product complies with German and, if available, European safety requirements.
	
	Insulation class: Class II

6.3.2 Features

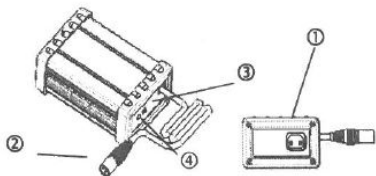

1. 3 Mains socket
2. 5 Battery charging plug
3. 2 POWER LED display
4. 1 CHARGING LED display

6.3.3 LED display

Green flashes	Waiting for connection to battery
Orange flashes	Pre-charge
Orange	Charging
Green and orange flashes	Charged 85 %
Green	Fully charged
Red flashes	Defect

6.3.4 Caution

- Before using the battery charger, read all instructions and cautionary markings.
- In order to extend the service life of the charger, you should not leave the electric vehicle connected to it for prolonged periods. Turn off the power after charging.
- Do not use the charger for totally discharged batteries or when the batteries are faulty.
- Use the charger in a well ventilated room.
- Only use the charger for gel or AGM batteries (16-60 Ah).
- Do not use for a voltage input other than that specified.
- The temperature of case will rise when charging. Avoid to touch the case directly.
- "Output Connector Not For Current Interrupting".
- For continued protection against risk of fire, replace only with same type and ratings of fuse.
- To reduce the risk of fire and electric shock, install in a temperature-and humidity-controlled indoor area relatively free of conductive contaminants.

- Power Supply Cord: Use UL Listed detachable power supply cord-No. 18 AWG, 2 conductors, flexible cord, rated 10 A, VW - I, 105 C, minimum 1.8 m , maximum 3 m long. Provided with a molded-on, non-polarized attachment plug with a 15 A, 125 V (NEMA1-15P) configuration and a molded-on connector which mates with the power inlet. The following cord types may be used:

Flexible cord type
S , SE,SO,SP-3 , SPT -3 , ST, STO, SJ , SJE, SJO , SJT, SJTO

6.3.5 Operating instructions

1. Make sure the battery charger output voltage is the same as the output voltage of the connecting battery.
2. Connect the power cord. The LED indicates red and green flash when AC power is on.
3. Connect the battery charger to the battery.
4. Start charging. Refer to 6.3.3 LED display, page 28.

6.3.6 Troubleshooting

- If the POWER LED (red) is off:
 - Check that the charging cable is correctly connected.
 - If the LED still does not light, the battery charger may be faulty. Contact your dealer.
- If the CHARGING LED is off:
 - Check that the charging cable is correctly connected.
 - If the battery is fully charged, the charger will switch to trickle charge mode and the CHARGING LED light goes out.
 - If the charging process was not started (orange LED), the battery could be faulty. Contact your dealer.

- If the green CHARGING LED keeps flashing, it cannot turn to indicate charging:
 - Check if the battery is connected successfully.
 - Check if the output connection is short or open.
 - If the battery connection is ok, the battery charger may be faulty.
- If the POWER LED (red) keeps flashing:
 - Check if the battery connection is reversed.
 - Check if the output connection is short or open.
 - Check if the environment temperature is too low ($< 0\text{ }^{\circ}\text{C}$)
 - If the POWER LED keeps flashing, the battery charger may be faulty.
- If the CHARGING LED does not change from orange to green:
 - The battery cannot be charged correctly. It may be faulty. Stop charging and contact your dealer.
- If the CHARGING LED changes from orange to green immediately:
 - The battery is either fully charged or faulty. Contact your dealer.

6.3.7 Technical specifications

Item	Battery charger (switch mode)
Model	4C24050A
Output current (DC)	5 A \pm 5 %
Charging voltage (DC)	28.8 V
Floating voltage (DC)	27.6 V

Input current (AC)	2.5 A max.
Input voltage (AC)	100 - 240 V, 50/60 Hz
Degree of efficiency	AC-DC 80%
Operating temperature	0 °C – 40 °C
Switching method	Switch mode
Charging method	Constant current, two levels of constant voltage method
Battery application	24 V gel or AGM batteries (16 Ah – 60 Ah)
Output detection	<ol style="list-style-type: none"> 1. Short-circuit protection 2. Reverse power protection 3. Overheat protection 4. Charging plug protection 5. Automatic cut off when reaching 12 hours constantly charging
Operating Humidity	20 % – 85 %
Dimensions L x W x H	190 mm x 100 mm x 55 mm
Weight	965 g
Color	Black

7 Transport

7.1 Transport - General information



WARNING!

Risk of severe or fatal injuries in the event of a traffic accident if this mobility device is used as a vehicle seat! It does not fulfill the requirements of ISO 7176-19:2001.

- Under no circumstances should this mobility device be used as a vehicle seat or to transport the user in a vehicle.

7.2 Dismantling the scooter for transport

Please proceed as follows to dismantle the scooter for transport:

1. Remove the seat. Refer to 4.4 Disengaging the seat to rotate it or remove it, page 16.
2. Remove the battery box. Refer to Removing/Installing the battery box.
3. Remove the drive unit. Refer to 7.2.2 Removing the drive unit, page 32.
4. Fold the tiller down to the lowest locked position. Refer to 4.6 Adjusting the tiller angle, page 17.

7.2.1 Removing/Installing the battery box



CAUTION!

Risk of strains from lifting heavy parts!

- Use proper lifting techniques.



CAUTION!

Risk of injury from unsecured scooter parts
Removing the battery box will release the LITE-LOCK™ mechanism allowing the front frame assembly to separate from the rear frame assembly.

- Do not lift or move the scooter without the battery box unless you want to disassemble it. Refer to 7.2 Dismantling the scooter for transport, page 31.

Removing the battery box

1. Remove the seat. Refer to 4.4 Disengaging the seat to rotate it or remove it, page 16.
- 2.

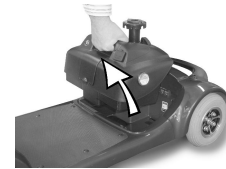
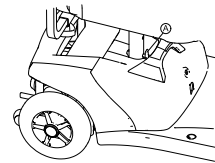

Grab the handle of the battery box, pull the battery box latch **A** with your thumb and remove the battery box.

Installing the battery box

1. Remove the seat. Refer to 4.4 Disengaging the seat to rotate it or remove it, page 16.
2. Holding the battery box handle, carefully lower the battery box on to the battery tray in the scooter.
3. Press down the battery box to engage the connector on the battery box with the connector on the scooter base.

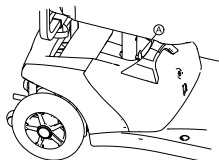

4. Ensure the battery box latch (A) engages the mounting hole in the seat post.
5. Reinstall the seat. Refer to 4.4 Disengaging the seat to rotate it or remove it, page 16.

7.2.2 Removing the drive unit



CAUTION!
Risk of strains from lifting heavy parts!
– Use proper lifting techniques.

1.

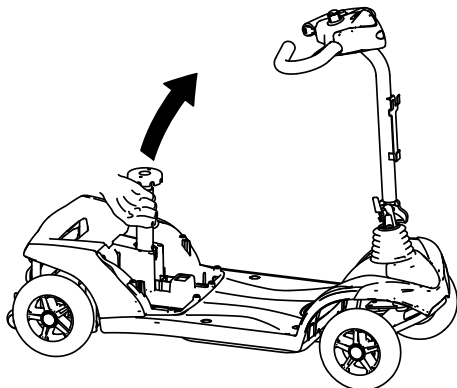

Pull up the seat post to lift up the chassis.

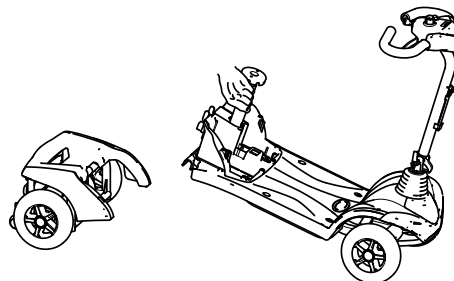

The drive unit separates from the chassis.

7.3 Reassembling the scooter



CAUTION!
Risk of strains from lifting heavy parts!
– Use proper lifting techniques.

1. Unfold the tiller. Refer to 4.6 Adjusting the tiller angle, page 17.
- 2.

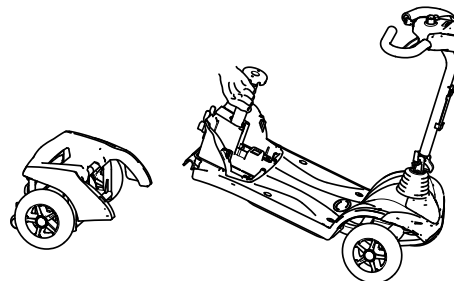

Pull up the seat post to lift up the chassis and hook the chassis onto the drive unit.

3. Refit the battery box. Refer to 7.2.1 Removing/Installing the battery box, page 31.

4.

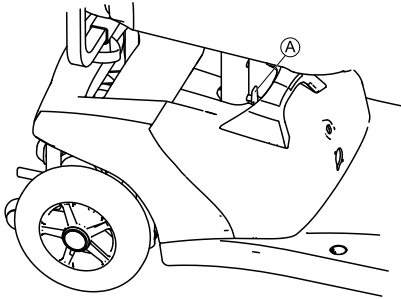

Make sure the latch **A** of the battery box is locked.

5. Refit the seat. Refer to 4.4 Disengaging the seat to rotate it or remove it, page 16.

8 Maintenance

8.1 Maintenance introduction

The term “Maintenance“ means any task performed to ensure that a medical device is in good working order and ready for use as intended. Maintenance encompasses different areas, such as everyday care and cleaning, inspection checks, repair tasks and refurbishment.



NOTE

- Have your vehicle checked once a year by an authorised Invacare dealer in order to maintain its driving safety and roadworthiness.

8.3 Inspection checks

The following table lists inspection checks that should be performed by the user and their intervals. If the mobility device fails to pass one of the inspection checks, please refer to the chapter indicated or contact your authorised Invacare dealer. A more comprehensive list of inspection checks and instructions for maintenance work can be found in the service manual for this device, which can be obtained from Invacare. That manual, however, is intended to be used by trained and authorised service technicians, and describes tasks which are not intended to be performed by the user.

Inspection work (to be carried out by user)	Before each journey	Weekly	Monthly
Horn:			
Check function Please contact your dealer in case of failure.	✓		
Tires:			
Check for foreign bodies (glass splinters, nails) and damage. Replace tire if necessary.		✓	
Batteries / electrical system			

8.2 Cleaning the mobility device

When cleaning the mobility device, pay attention to the following points:

- Only use a damp cloth and gentle detergent.
- Do not use any abrasive or scouring agents.
- Do not subject the electronic components to any direct contact with water.
- Do not use any high-pressure cleaning devices.

Disinfection

Spray or wipe disinfection using a tested and recognised product is permitted. A list of the current permitted disinfectants is available from the Robert Koch Institute at <http://www.rki.de>.

Inspection work (to be carried out by user)	Before each journey	Weekly	Monthly
Check battery charging status. Charge batteries if necessary (refer to 6.2.3 How to charge the batteries, page 24).	✓		
Checked all connecting plugs for condition and stable connections. Press connecting plugs firmly together if necessary.			✓
Wheel lock (if fitted):			
Check wheel lock function. Please contact your dealer if the brake is defective.	✓		

9 After Use

9.1 Disposal

- The equipment wrapping is potentially recyclable.
- The metal parts are used for scrap metal recycling.
- The plastic parts are used for plastic recycling.
- Electric components and printed circuit boards are disposed of as electronic scrap.
- Exhausted or damaged batteries can be returned to your medical equipment supplier or Invacare.
- Disposal must be carried out in accordance with the respective national legal provisions.
- Ask your city or district council for details of the local waste management companies.

10 Troubleshooting

10.1 Diagnosis and fault repair

The electronic system offers diagnostic information to support the technician during the recognition and rectification of faults on the scooter. If there is a fault, the status display flashes several times, pauses, then flashes again. The type of fault is displayed by the number of flashes in each group, which are also known as the "flash code".

The electronic system reacts differently depending on the seriousness of the fault and its effect on user safety. It can, for example:

- Show the flash code as a warning and allow both driving and normal operation to continue.
- Display the flash code, stop the scooter and prevent further travel until the electronic system has been switched off and switched on again.
- Display the flash code, stop the scooter and not permit further travel until the fault has been rectified.

10.1.2 Error codes and diagnostic codes

Flash code	Fault	Consequence for the scooter	Comments
1	Battery must be charged	Continues to drive	<ul style="list-style-type: none"> • The batteries are discharged. Charge the battery as soon as possible.
2	Battery voltage too low	Stops driving	<ul style="list-style-type: none"> • The batteries are depleted. Charge batteries. • If you switch the scooter off for a few minutes, the battery can often recuperate to such a stage that a short journey is still possible. You should only do this in an emergency, however, because this causes the batteries to become excessively discharged.

You can find detailed descriptions of individual flash codes, including possible causes and fault repair, in the section entitled 10.1.2 Error codes and diagnostic codes, page 37.

10.1.1 Error diagnosis

If the scooter shows a failure, please use the following guide to locate the fault.



NOTE:

- Before making any diagnosis, ensure that the scooter has been switched on at the keyswitch.

If the status display is OFF:

- Check whether the keyswitch is SWITCHED ON.
- Check whether all cables are correctly connected.

If the status bar indicator is FLASHING:

- Count the number of flashes and then proceed to the next section.

Flash code	Fault	Consequence for the scooter	Comments
3	Battery voltage too high	Stops driving	<ul style="list-style-type: none"> • The battery voltage is too high. If the battery charger is connected, disconnect it from the scooter. • The electronic system charges the batteries when running downhill and when braking. This fault is caused when the battery voltage becomes too high during this process. Switch the scooter off and on again.
4	Power time exceeded	Stops driving	<ul style="list-style-type: none"> • The maximum current was exceeded over too long a period, probably because the motor was overloaded or has been working against an immovable resistance. Switch the scooter off, wait a few minutes and then switch on again. • The electronic system has determined a motor short-circuit. Check the wiring harness for short-circuit and check the motor. • Contact your Invacare dealer.
5	Brake failure	Stops driving	<ul style="list-style-type: none"> • Ensure that the disengaging lever is in the engaged position. • There is a defect in the braking coil or in the cabling. Check the magnetic brake and cabling for open or short-circuited circuitry. Contact your Invacare dealer.
6	No neutral position when switching Scooter on.	Stops driving	<ul style="list-style-type: none"> • Drive lever is not in neutral when the keyswitch was turned. Put the drive lever in neutral, turn the power off and then turn on again. • It may be necessary to replace the drive lever. Contact your Invacare dealer.
7	Fault in speed potentiometer	Stops driving	<ul style="list-style-type: none"> • The drive lever electronics could be faulty or incorrectly connected. Check the cabling for open or short-circuited circuitry. • Potentiometer is not correctly adjusted. Put the potentiometer into the centre position.

Flash code	Fault	Consequence for the scooter	Comments
8	Motor voltage error	Stops driving	<ul style="list-style-type: none"> The motor or its cabling is defective Check the cabling for open or short-circuited circuitry.
9	Miscellaneous internal fault	Stops driving	<ul style="list-style-type: none"> Contact your Invacare dealer.
10	Push/freewheel mode error	Stops moving	<ul style="list-style-type: none"> The scooter has exceeded the permissible maximum speed during pushing or freewheeling. Switch the electronics system off and on again.

10.2 Resetting the circuit breaker



WARNING!

- NEVER defeat or bypass the circuit breaker.
- ONLY replace with a circuit breaker of the same rating.



- Key must be removed from ignition before resetting circuit breaker.
- Resetting the circuit breaker may be needed if the scooter does not turn on and the reset button has popped out about 6 mm.

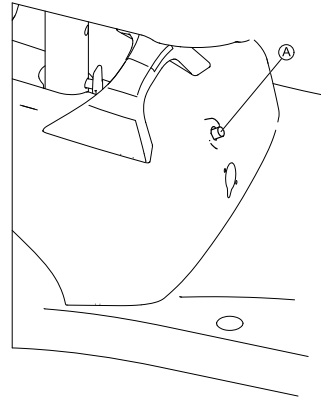

- To reset, press the circuit breaker button **A** located on the front of the battery box.

II Technical data

II.1 Technical specifications

The technical information provided hereafter applies to a standard configuration or represents maximum achievable values. These can change if accessories are added. The precise changes to these values are detailed in the sections for the respective accessories.

Permissible operating and storage conditions	
Temperature range for operation according to ISO 7176-9:	• -25° ... +50 °C
Temperature range for storage according to ISO 7176-9:	• -40° ... +65 °C

Electrical system	
Motor	• 1 x 200 W
Batteries	• 2 x 12 V/12 Ah (C20) leakproof/AGM • 2 x 12 V/18 Ah (C20) leakproof/AGM
Main fuse	• 40 A

Charging device	For 12 Ah batteries	For 18 Ah batteries
Output current	• 2 A ±	• 5 A ± 5 %
Output voltage	• 24 V nominal (12 cells)	• 28.8 V nominal (12 cells)
Input voltage	• 200 - 250 V nominal	• 100 - 240 V nominal
Operating temperature (surroundings)	• -25° ... +50 °C	• 0° ... +40 °C
Storage temperature	• -40° ... +65 °C	

Tires	
Tire type	• 200 x 50 puncture-proof • 210 x 65 puncture-proof

Driving characteristics	
Speed (dependent on country - please ask your dealer which speed is available in your country.)	<ul style="list-style-type: none"> • 6 km/h • 8 km/h
Min. braking distance	<ul style="list-style-type: none"> • 1000 mm (6 km/h) • 1500 mm (8 km/h)
Max. safe slope ***	<ul style="list-style-type: none"> • 6° (10.5 %)
Max. climbable obstacle height	<ul style="list-style-type: none"> • 45 mm
Turning diameter	<ul style="list-style-type: none"> • 1940 mm (3-wheel) • 2200 mm (4-wheel)
Drive range in accordance with ISO 7176-4:2008 *	<ul style="list-style-type: none"> • 16 km (18 Ah batteries) • 11 km (12 Ah batteries)

Dimensions	
Overall length	<ul style="list-style-type: none"> • 1010 mm
Max. total width	<ul style="list-style-type: none"> • 610 mm
Total height	<ul style="list-style-type: none"> • 840 mm
Seat height **	<ul style="list-style-type: none"> • 490 mm
Seat width	<ul style="list-style-type: none"> • 465 mm
Seat depth	<ul style="list-style-type: none"> • 400 mm
Armrest height	<ul style="list-style-type: none"> • 225 mm

Weight	3-wheel	4-wheel
Curb weight	<ul style="list-style-type: none"> • 41.7 kg (12 Ah batteries) • 46.4 kg (18 Ah batteries) 	<ul style="list-style-type: none"> • 44.2 kg (12 Ah batteries) • 48.9 kg (18 Ah batteries)

Components weight	
Front section	<ul style="list-style-type: none"> • 13.1 kg (3-wheel) • 15.6 kg (4-wheel)
Drive unit	<ul style="list-style-type: none"> • 9.6 kg
Seat	<ul style="list-style-type: none"> • 9.6 kg
Battery box 12 Ah	<ul style="list-style-type: none"> • 9.4 kg
Battery box 18 Ah	<ul style="list-style-type: none"> • 14.1 kg

Loading	
Max. load	<ul style="list-style-type: none"> • 136 kg

Axle loads	
Max. front axle load	<ul style="list-style-type: none"> • 60 kg
Max. rear axle load	<ul style="list-style-type: none"> • 130 kg

* Note: The drive range of a mobility device is strongly influenced by external factors, such as the charging state of the batteries, surrounding temperature, local topography, road surface characteristics, tire pressure, weight of driver, drive style and use of batteries for lighting, servos etc.

The specified values are theoretical maximum achievable values measured according to ISO 7176-4:2008.

** Measured without seat cushion

*** Static stability according to ISO 7176-1 = 9° (15.8 %)

Dynamic stability according to ISO 7176-2 = 6° (10.5 %)

Notes

Australia:

Invacare Australia PTY. Ltd.
1 Lenton Place, North Rocks N.S.W.
2151, Sydney, Australia
Tel. +61-2-8839-5333
Fax +61-2-8839-5353
sales@invacare.com.au
www.invacare.com.au

United Kingdom:

Invacare Limited
Pencoed Technology Park, Pencoed
Bridgend CF35 5AQ
Tel: (44) (0) 1656 776 222
Fax: (44) (0) 1656 776 220
uk@invacare.com
www.invacare.co.uk

Canada:

Invacare Corporation
570 Matheson Blvd E Unit 8
Mississauga Ontario
L4Z 4G4 Canada
800-668-5324

Eastern Europe & Middle East:

Invacare GmbH, EDO
Kleiststraße 49
D-32457 Porta Westfalica
Tel: (49) (0)57 31 754 540
Fax: (49) (0)57 31 754 541
edo@invacare.com
www.invacare.eu.com

Ireland:

Invacare Ireland Ltd,
Unit 5 Seatown Business Campus
Seatown Road, Swords, County Dublin
Tel : (353) | 810 7084
Fax: (353) | 810 7085
ireland@invacare.com
www.invacare.ie

New Zealand:

Invacare New Zealand Ltd
4 Westfield Place, Mt Wellington,
Auckland
Tel: 0064 9 917 3939
Fax: 0064 9 917 3957
sales@invacare.co.nz
www.invacare.co.nz

EC	REP
----	-----

European representative:

EMERGO EUROPE
Molenstraat 15
2513 BH, The Hague
The Netherlands

**Manufacturer:**

CHIEN TI ENTERPRISE CO. LTD.
No. 13, Lane 227, Fu Ying Road
Hsin Chuang, Taipei, Taiwan
R.O.C.

1576371-B 2014-03-25



Making Life's Experiences Possible™



Yes, you can.®